

S6

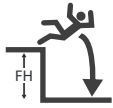

EN1176

2.56m

# EN1176

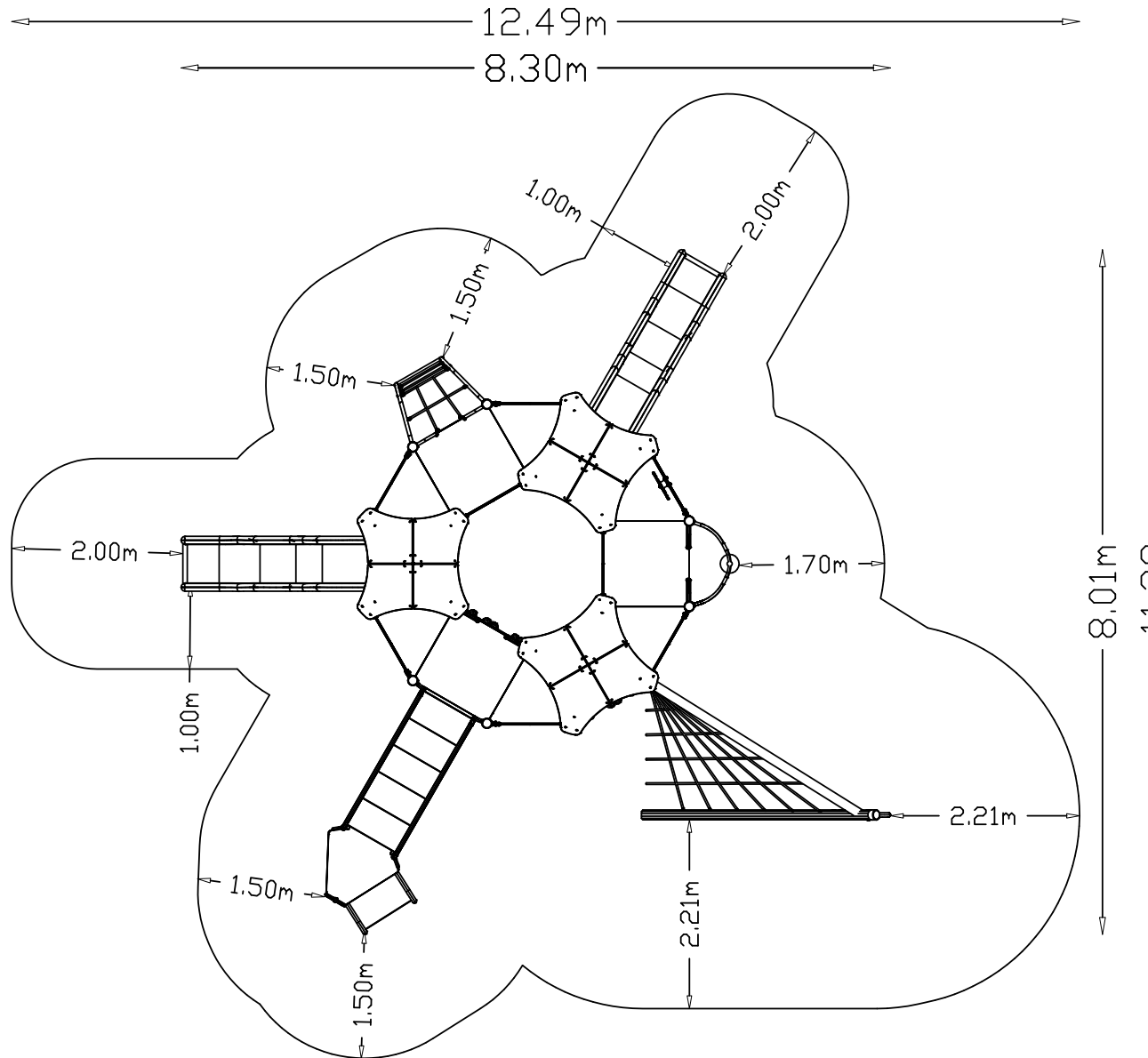





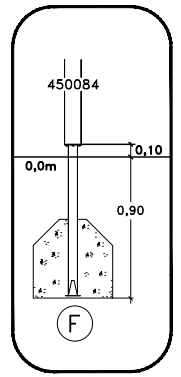
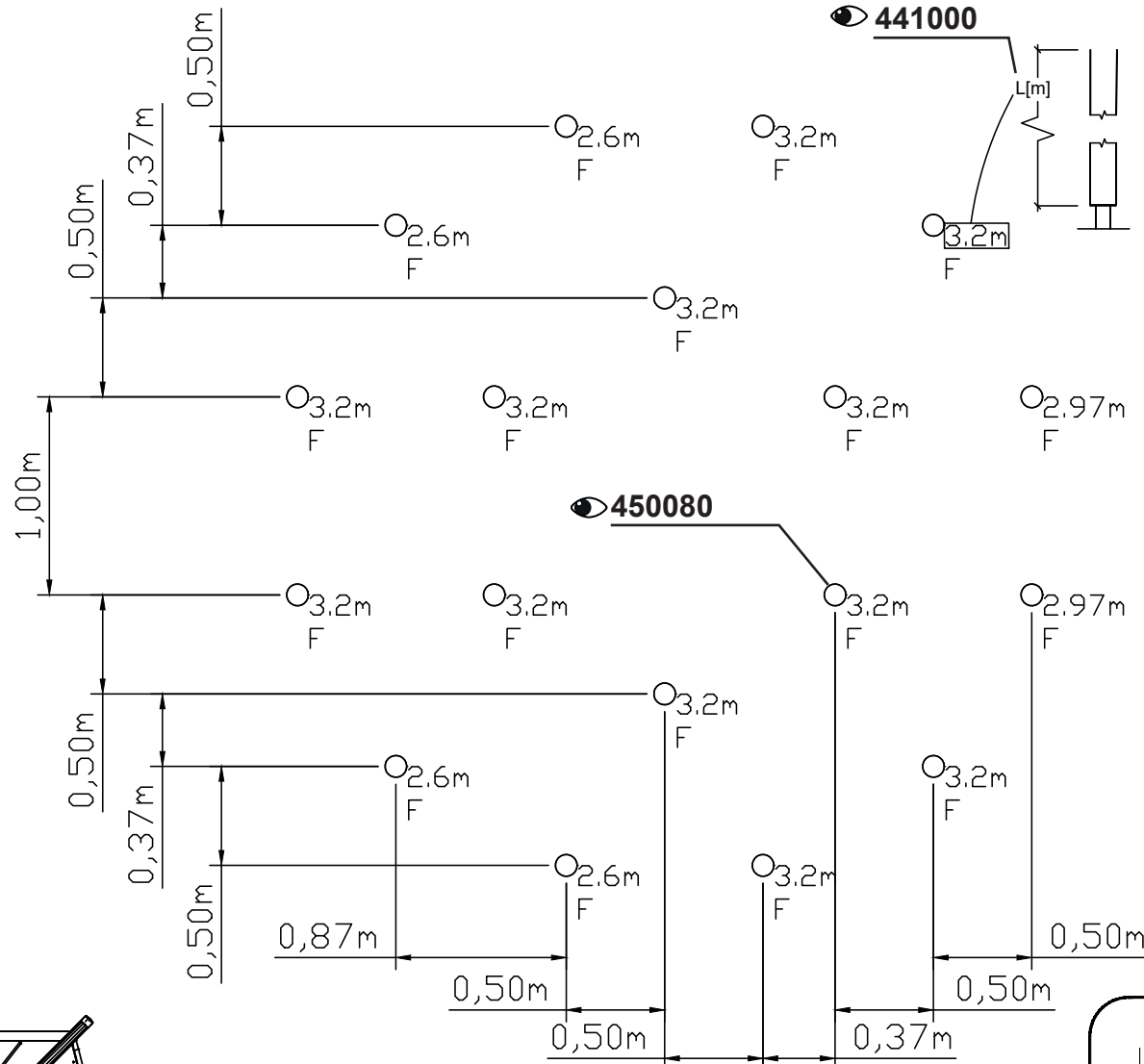
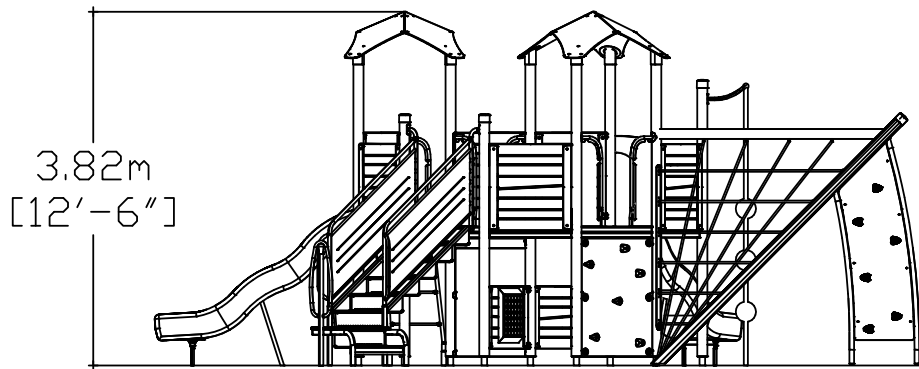
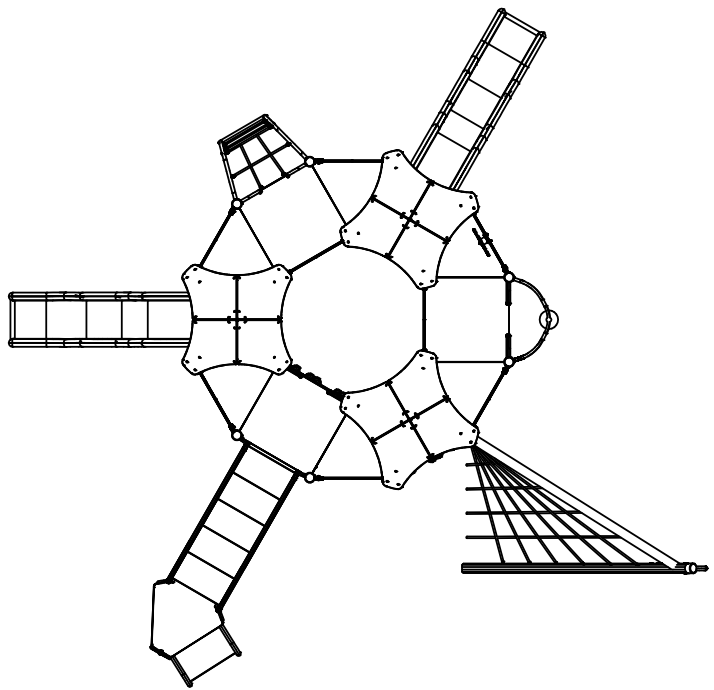

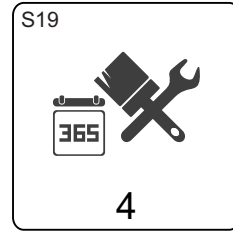
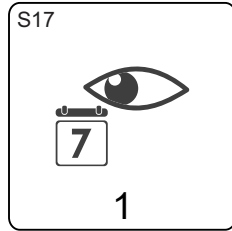
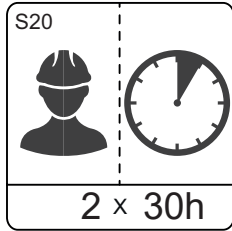
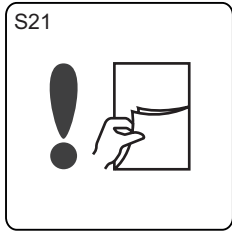

**Install 101**  
**260329**  
**420960**  
**420995**  
**441000**  
**450080**  
**45275323**  
**45475323**  
**MA422U77151**  
**MA424U77151**  
**MASW103874**  
**MASW35156**  
**MASW39775**  
**MASW41284**  
**MASW42193**  
**MASW53817**  
**MASW57252**  
**MASW57255**  
**MASW63820**  
**MASW85869**  
**MAUSW37447**  
**ST403**

450080

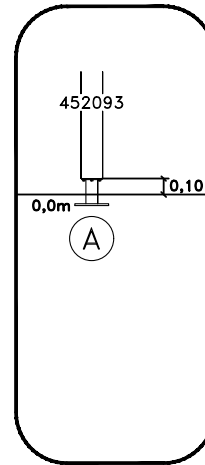

**Above Ground**  
**OM**

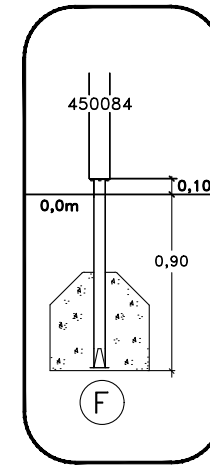

**Cast Loose Fill**  
**BM**  
 8102040

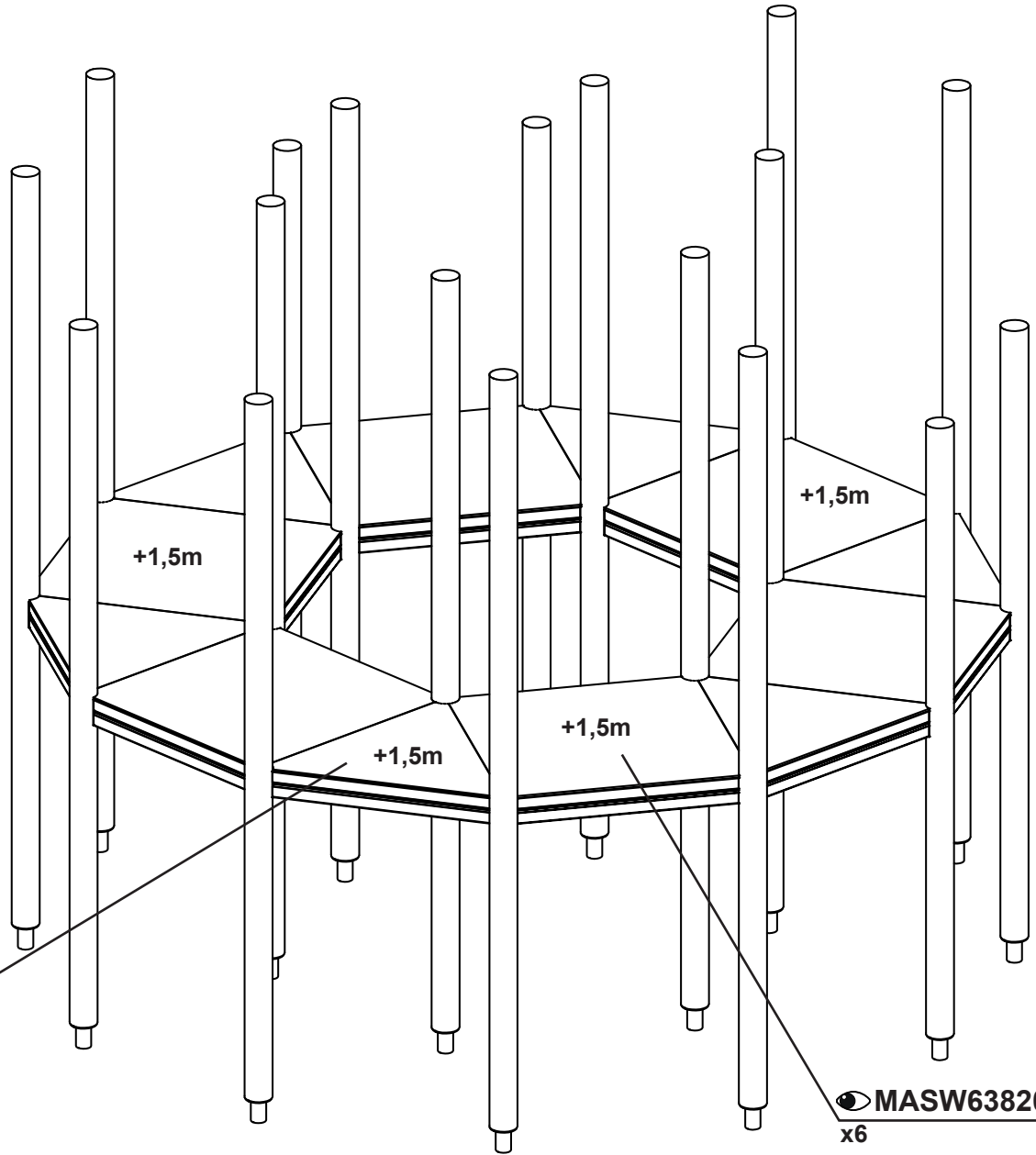
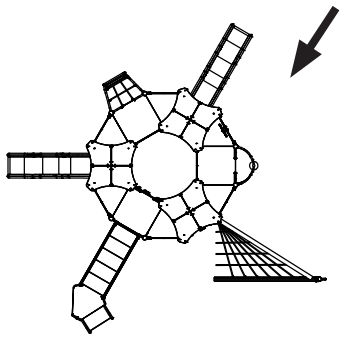

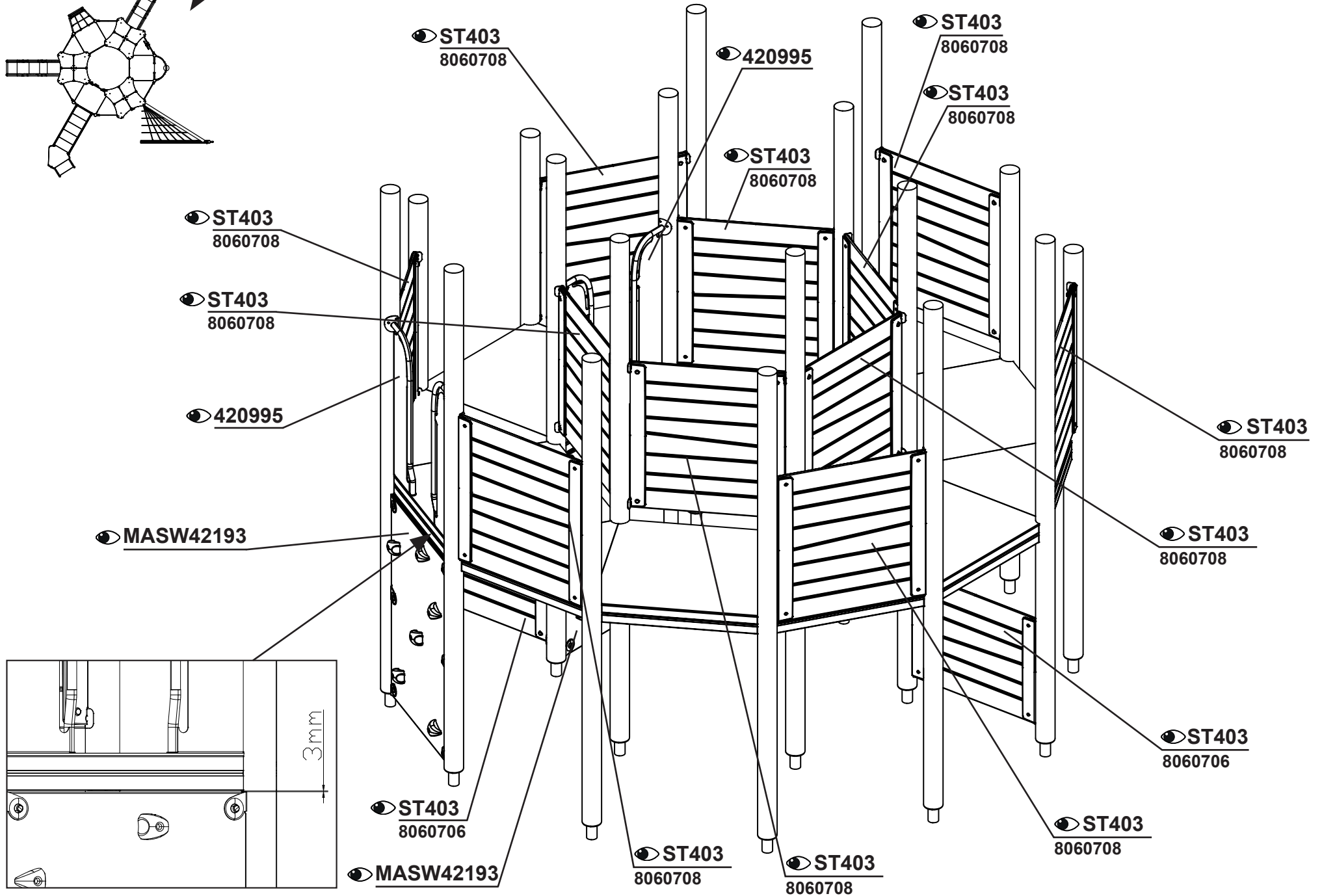
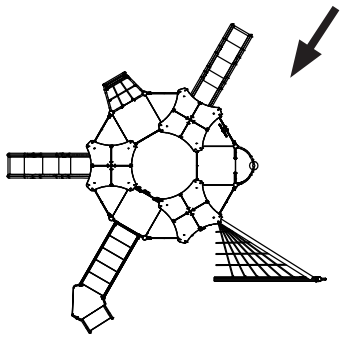



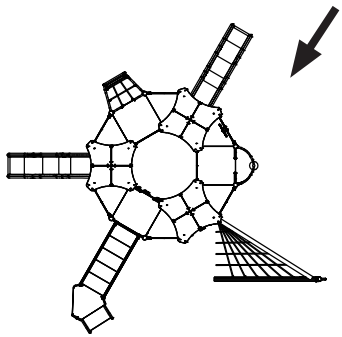

● 45475323 [BM]

● 45275323 [OM]

● MAUSW37447

+2,56m

● MASW57255 [BM]

● MASW57252 [OM]

● 420960

● MA424U77151 [BM]

● MA422U77151 [OM]

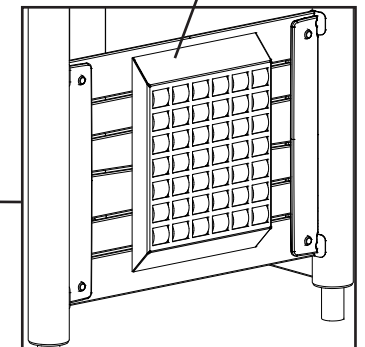

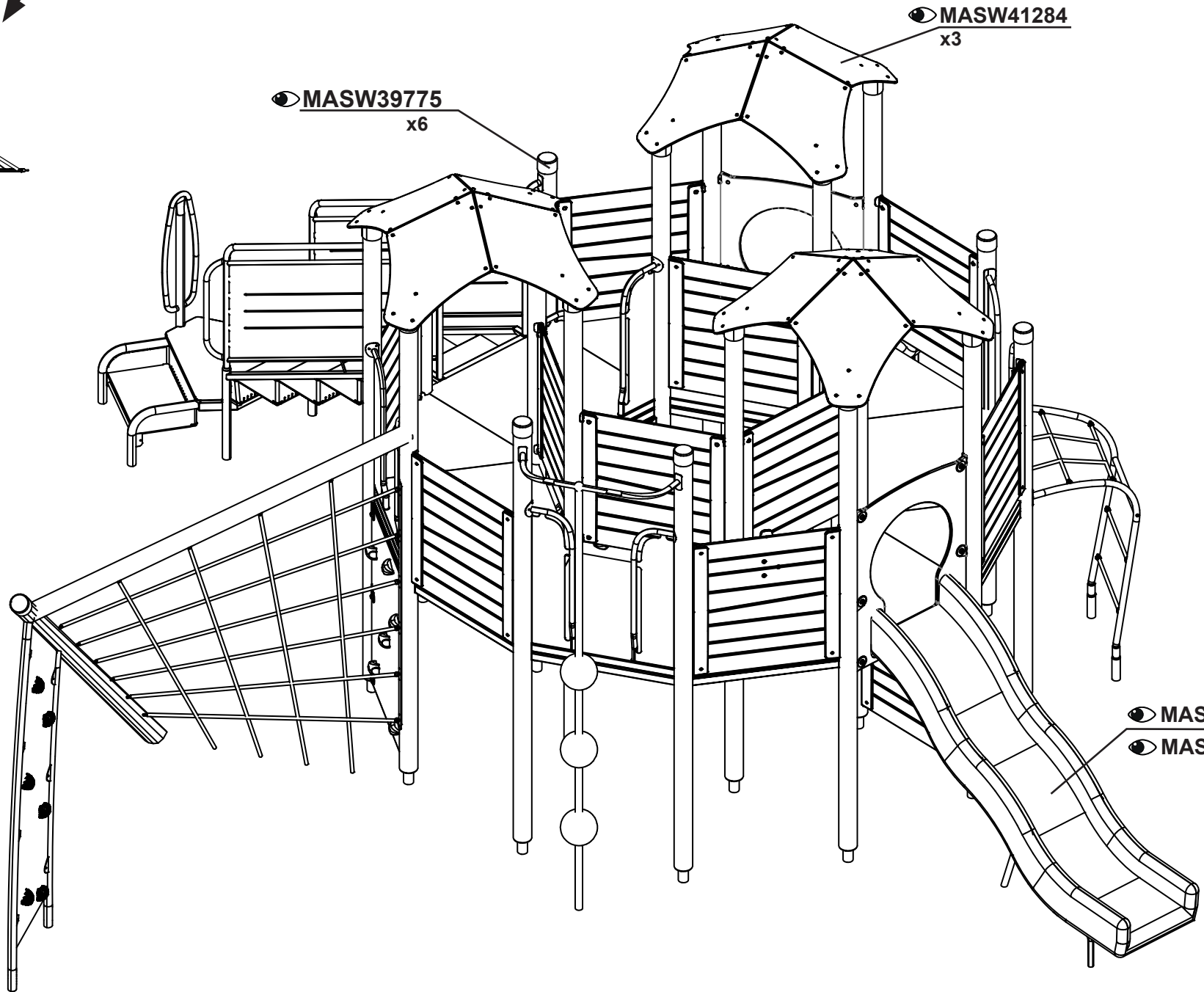
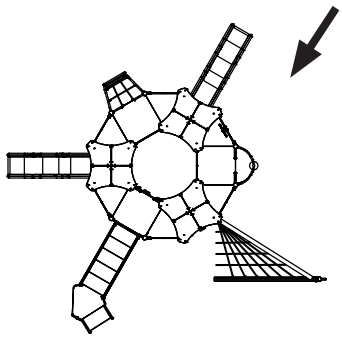

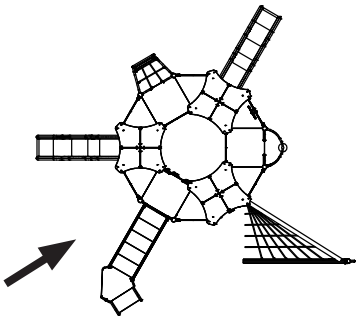

**260329**

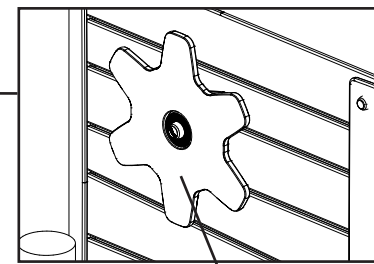

**MASW35156**

**MASW103874 [BM]**  
**MASW85869 [OM]**

**MASW42193**

